

StepArray+

User Manual



Contents

Contents	3
1 Introduction	4
2 System components	5
3 Assembling	6
4 Wiring	7
5 StepArray+ control software	8
6 Installation of the columns	11
7 Specifications	13
8 Acoustical data	15
List of Figures	22

1 Introduction

StepArray+ column speakers ensure perfect speech intelligibility and optimal acoustic comfort, even in noisy and reverberant venues. They are based on the DGRC (Digital & Geometric Radiation Control) principle patented by Active Audio.

Compared with a classic sound system in which each loudspeaker is controlled independently, the DGRC method makes it possible to decrease the number of channels to be controlled, thereby enhancing economic efficiency.

StepArray+ also allows the use of existing network cables and helps to achieve significant savings in wiring, with up to 64 channels on a single Ethernet cable. StepArray+ combines the features of Dante™ and StepArray to achieve ever higher levels of efficiency and flexibility.

The StepArray+ range includes 6 models of column speakers, from 1.50m to 4.50m high.

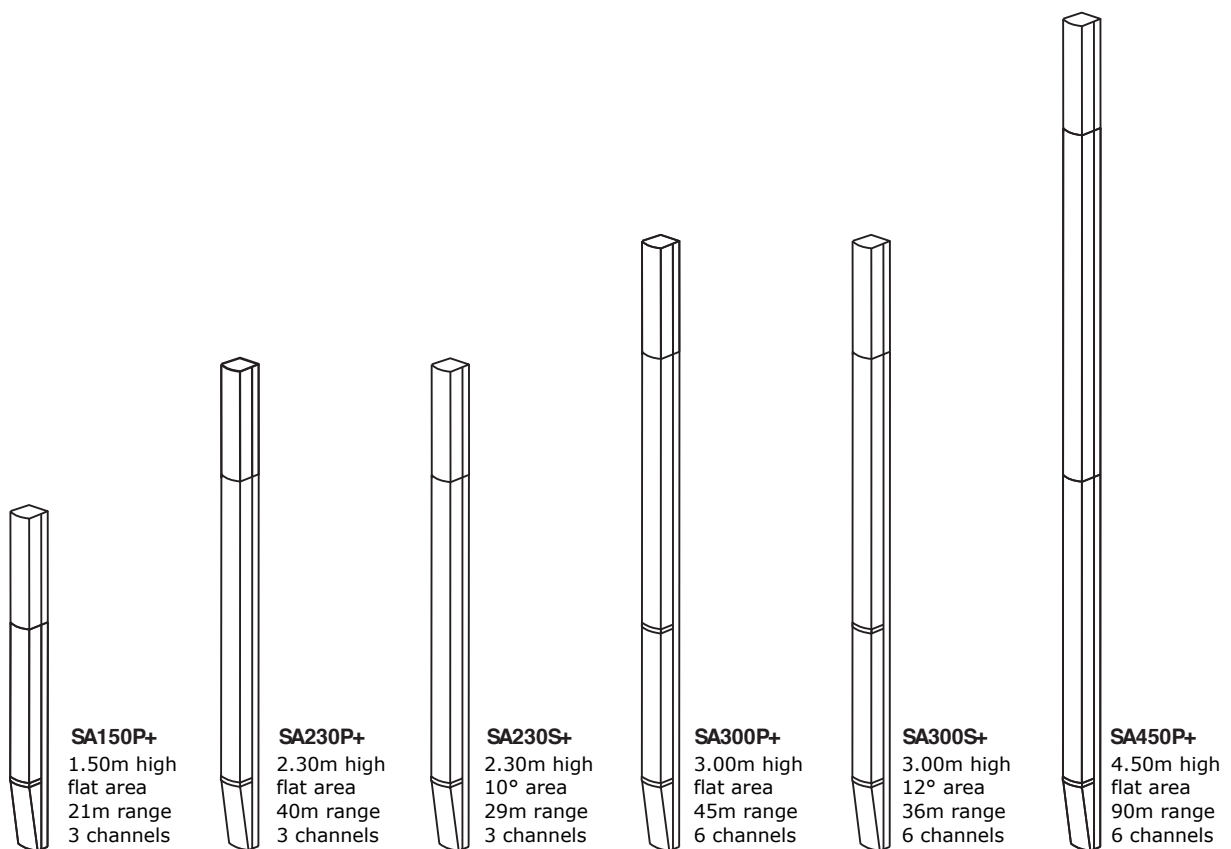

2 System components

StepArray+ columns are made of two parts: a standard StepArray passive column, and its companion StepArray+ amplifier module.

StepArray+
amplifier module

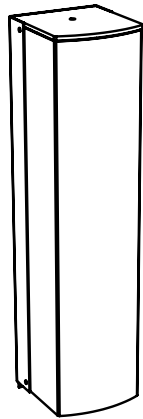

StepArray
passive column

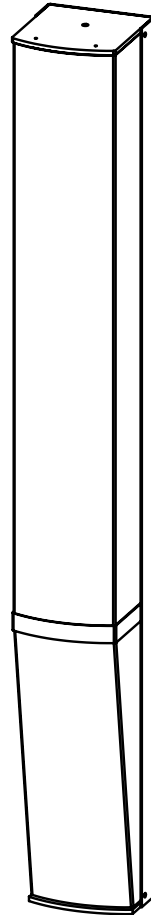

3 Assembling

1. Remove the back plate of the amplifier module.

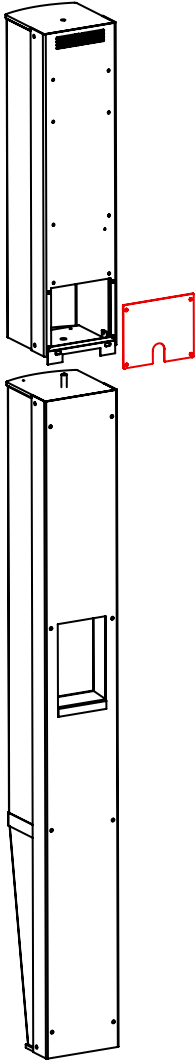

2. Place the amplifier module at the top of the passive column.

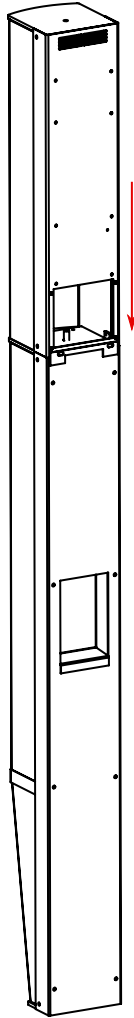

3. Secure the amplifier module using the supplied M8 nut.

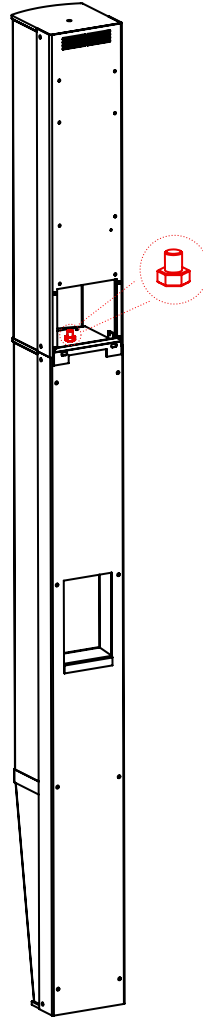

4. After wiring, close the connection box by mounting the back plate.

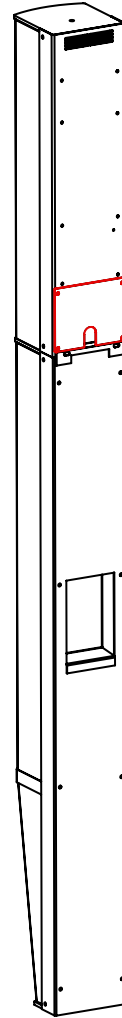

4 Wiring

All the connections of a StepArray+ column are available in the connection box at the back of the StepArray+ amplifier module.

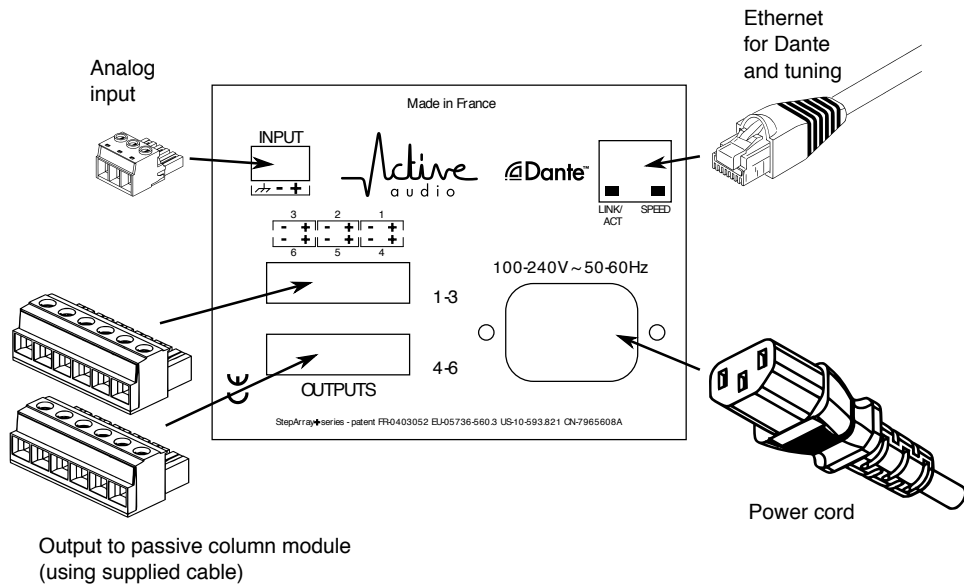

Example setup using Dante®

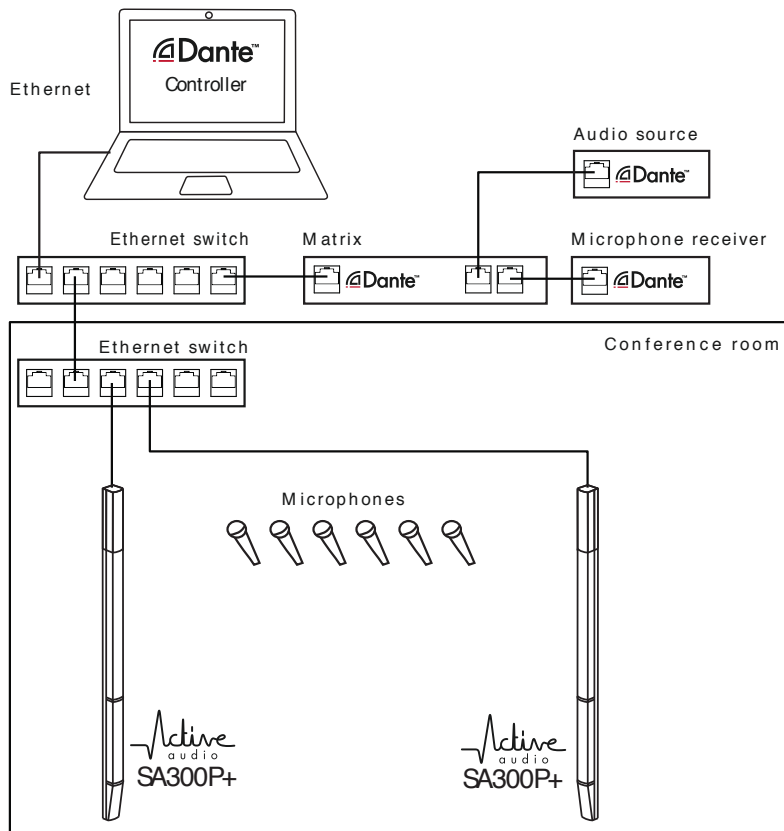

5 StepArray+ control software

The StepArray+ control software is available for Windows and OSX operating systems. Installers can be found on the supplied USB key or on Active Audio's website by following this link: <http://www.activeaudio.fr/downloads>.

5.1 System requirements

Processor	1Ghz or better
Memory	512Mbyte of RAM
Network	Standard wired Ethernet network interface (100Mbps or Gigabit). Wireless LAN (Wi-Fi) Ethernet interfaces are not supported
Operating System	Windows 7 SP1 or newer Mac OS X 10.7.5 or newer

5.2 Installation on Windows

Start the installer package by double-clicking on it, then follow the instructions

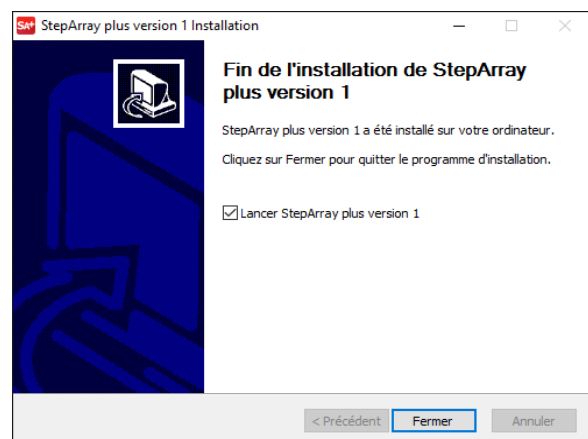
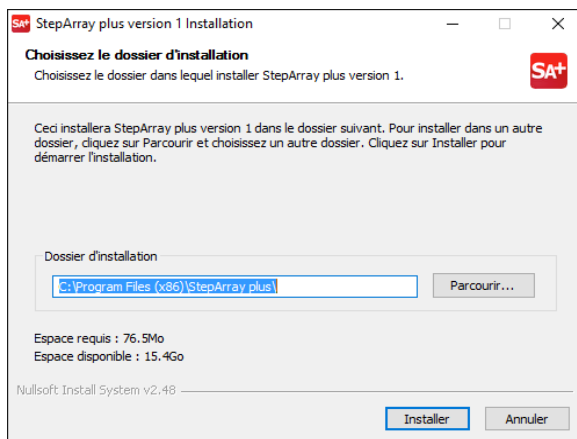

5.3 Installation on OSX

Start the installer package by double-clicking on it, then follow the instructions.

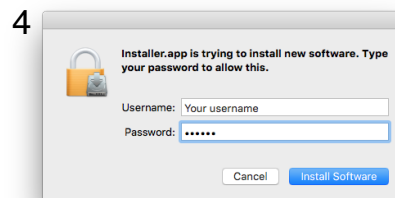
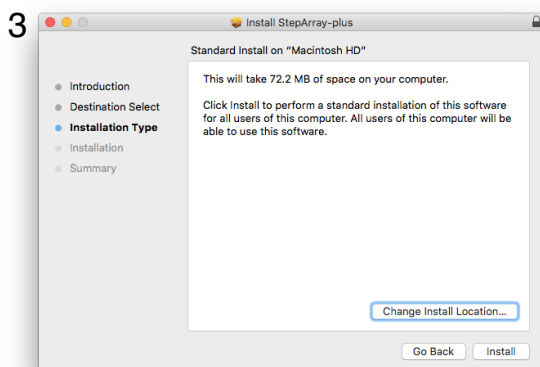
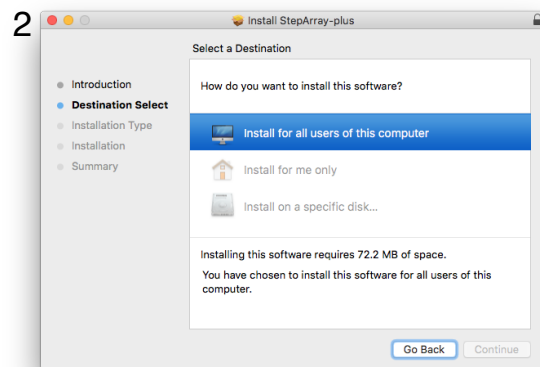
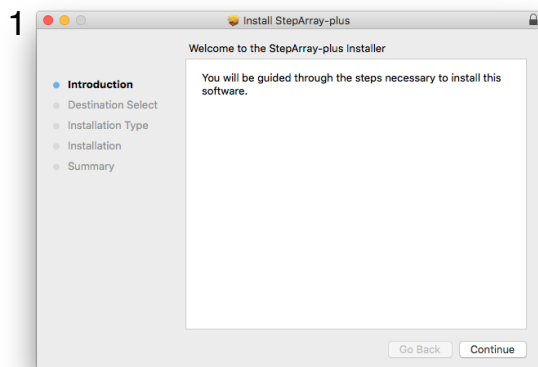

The installation program needs your permission to install the Dante service.

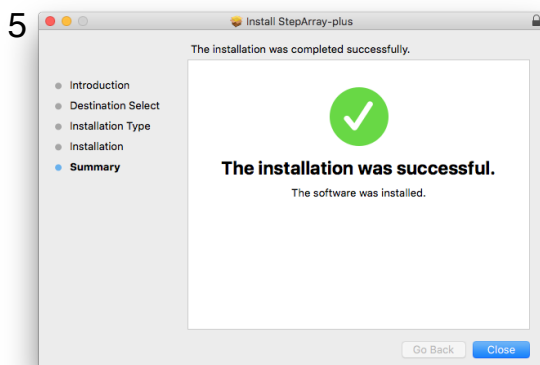

5.4 Using the StepArray+ software

The StepArray+ control software gives access to the following functions:

- input selection: Dante or analog input
- general output volume
- steering parameters for directivity control

The StepArray+ control software **does not include Dante routing functionality**.
 When using Dante to transmit audio, you will need the *Dante Controller* software to assign Dante channels to StepArray+ columns. *Dante Controller* is available free of charge from the Audinate website: <https://www.audinate.com/products/software/dante-controller>.

When launching the StepArray+ control software, the first screen lists all the StepArray+ columns it can find on the network. The first connection to a StepArray+ column can take up to 1 minute: this is the time needed to initiate the communication.

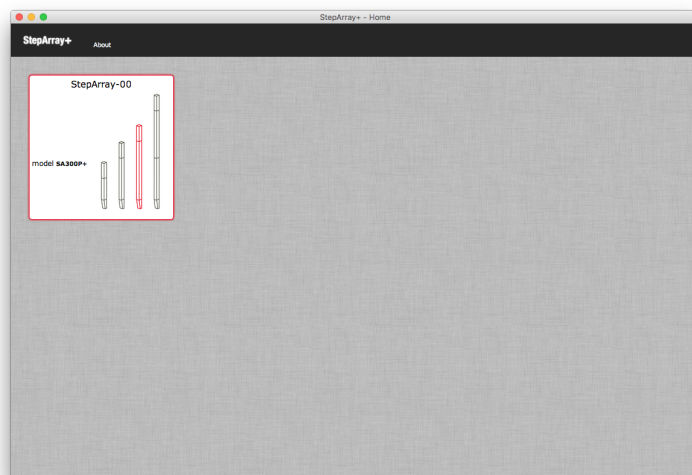

Figure 1 – StepArray+ control software: main screen.

A click on a StepArray+ box leads to the settings screen of that specific column. All the parameters of the column can be changed within that screen.

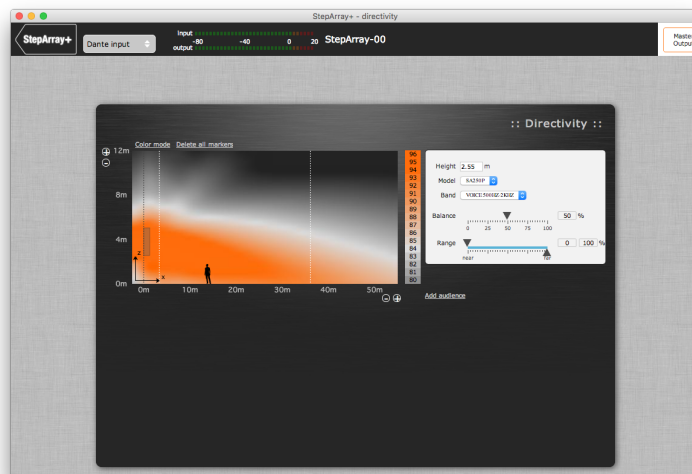

Figure 2 – StepArray+ control software: column settings screen.

6 Installation of the columns

StepArray+ columns are mounted vertically, usually on a wall, using the supplied brackets. Figure 3 illustrates the steps to follow for column mounting. See also figure 4 on the next page for technical drawings of the brackets.

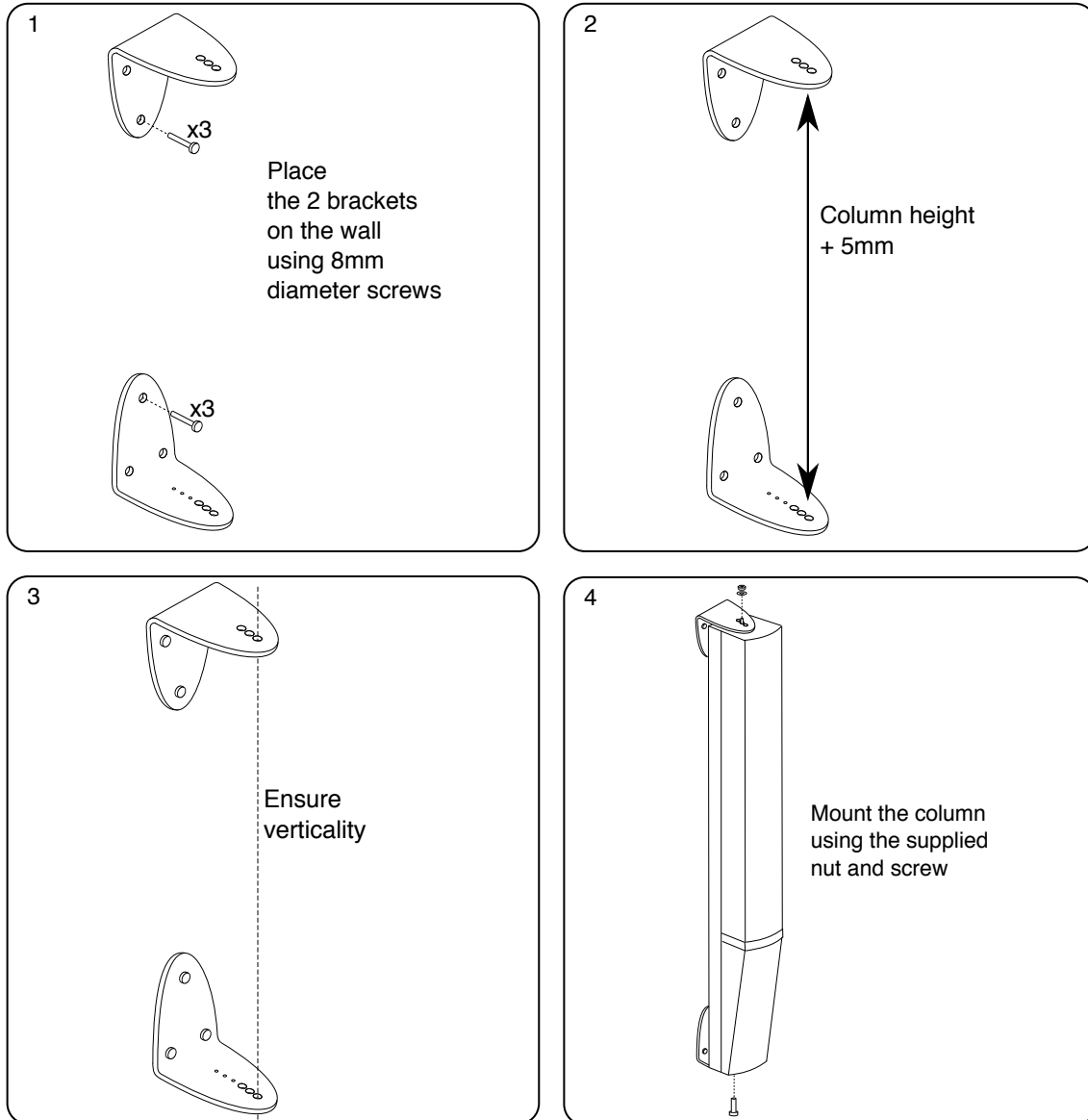

Figure 3 – Column mounting on a wall



It is important to **ensure verticality** when mounting StepArray+ columns.

Dimensions of the brackets

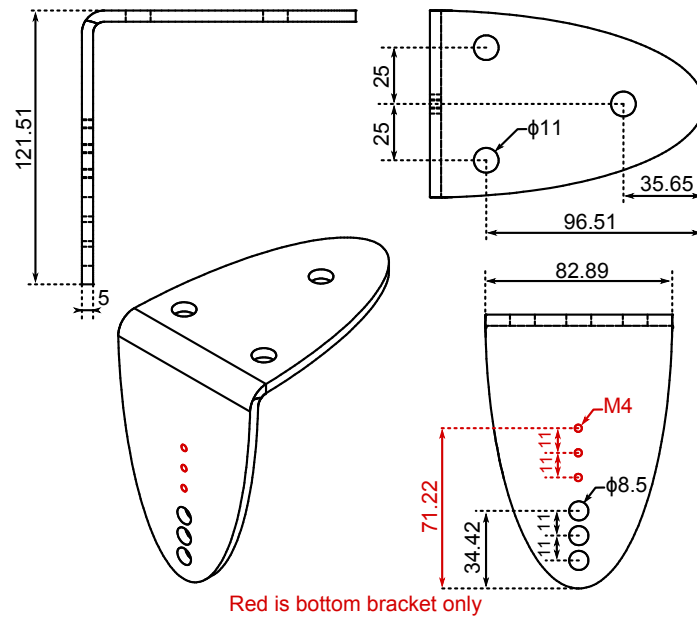



Figure 4 – Fixing brackets for wall mounting of StepArray columns.

7 Specifications

SA150P+

	Acoustical data		Electrical data	
	range ±3dB	15m	max output power	450W
	range ±5dB	21m	max continuous output power (25°)	300W
	max SPL	95dB SPL at 10m	power consumption	Idle 22W
	angle of audience	0°-5°		Typ. 80W
	frequency bandwidth (-10dB)	110Hz-19kHz		Max 500W
	horizontal opening angle	180°	number of Channels	3
			power supply	85-264VAC 45-65Hz
	Mechanical data		Inputs	
	net weight	14 kg	1x balanced analog 3-pin input	
shipping weight	17 kg	1x Dante™ input		
height	1524mm	Network		
width	124mm	1x RJ45 connector, Dante™		
depth	131mm	max. operating ambient temperature		
standard colors	white RAL 9016 black RAL 9005	60°C		

SA230P+

	Acoustical data		Electrical data	
	range ±3dB	30m	max output power	450W
	range ±5dB	40m	max continuous output power (25°)	300W
	max SPL	95dB SPL at 15m	power consumption	Idle 22W
	angle of audience	0°-5°		Typ. 80W
	frequency bandwidth (-10dB)	110Hz-19kHz		Max 500W
	horizontal opening angle	180°	number of Channels	3
			power supply	85-264VAC 45-65Hz
	Mechanical data		Inputs	
	net weight	22 kg	1x balanced analog 3-pin input	
shipping weight	24 kg	1x Dante™ input		
height	2340mm	Network		
width	124mm	1x RJ45 connector, Dante™		
depth	135mm	max. operating ambient temperature		
standard colors	white RAL 9016 black RAL 9005	60°C		

SA230P+

	Acoustical data		Electrical data	
	range ±3dB	22m	max output power	450W
	range ±5dB	29m	max continuous output power (25°)	300W
	max SPL	95dB SPL at 15m	power consumption	Idle 22W
	angle of audience	5°-20°		Typ. 80W
	frequency bandwidth (-10dB)	110Hz-19kHz		Max 500W
	horizontal opening angle	180°	number of Channels	3
			power supply	85-264VAC 45-65Hz
	Mechanical data		Inputs	
	net weight	22 kg	1x balanced analog 3-pin input	
shipping weight	24 kg	1x Dante™ input		
height	2340mm	Network		
width	124mm	1x RJ45 connector, Dante™		
depth	135mm	max. operating ambient temperature		
standard colors	white RAL 9016 black RAL 9005	60°C		

SA300P+

	Acoustical data		Electrical data	
	range ±3dB	35m	max output power	900W
	range ±5dB	45m	max continuous output power (25°)	600W
	max SPL	95dB SPL at 20m	power consumption Idle	41W
	angle of audience	0°-5°	Typ.	150W
	frequency bandwidth (-10dB)	110Hz-19kHz	Max	1000W
	horizontal opening angle	180°	number of Channels	6
			power supply	85-264VAC 45-65Hz
	Mechanical data		Inputs	
	net weight	29 kg	1x balanced analog 3-pin input	
shipping weight	33 kg	1x Dante™ input		
height	3005mm			
width	124mm			
depth	159mm			
standard colors	white RAL 9016 black RAL 9005	Network		
		1x RJ45 connector, Dante™		
		max. operating ambient temperature	60°C	

SA300S+

	Acoustical data		Electrical data	
	range ±3dB	28m	max output power	900W
	range ±5dB	36m	max continuous output power (25°)	600W
	max SPL	95dB SPL at 20m	power consumption Idle	41W
	angle of audience	5°-20°	Typ.	150W
	frequency bandwidth (-10dB)	110Hz-19kHz	Max	1000W
	horizontal opening angle	180°	number of Channels	6
			power supply	85-264VAC 45-65Hz
	Mechanical data		Inputs	
	net weight	29 kg	1x balanced analog 3-pin input	
shipping weight	33 kg	1x Dante™ input		
height	3005mm			
width	124mm			
depth	159mm			
standard colors	white RAL 9016 black RAL 9005	Network		
		1x RJ45 connector, Dante™		
		max. operating ambient temperature	60°C	

SA450P+

	Acoustical data		Electrical data	
	range ±3dB	68m	max output power	900W
	range ±5dB	90m	max continuous output power (25°)	600W
	max SPL	95dB SPL at 30m	power consumption Idle	41W
	angle of audience	0°-3°	Typ.	150W
	frequency bandwidth (-10dB)	110Hz-19kHz	Max	1000W
	horizontal opening angle	180°	number of Channels	6
			power supply	85-264VAC 45-65Hz
	Mechanical data		Inputs	
	net weight	44 kg	1x balanced analog 3-pin input	
shipping weight	47 kg	1x Dante™ input		
height	4596mm			
width	124mm			
depth	135mm			
standard colors	white RAL 9016 black RAL 9005	Network		
		1x RJ45 connector, Dante™		
		max. operating ambient temperature	60°C	

8 Acoustical data

All data presented below is obtained with columns in their nominal position and using nominal DSP filtering parameters (flat EQ, etc).

8.1 Common data

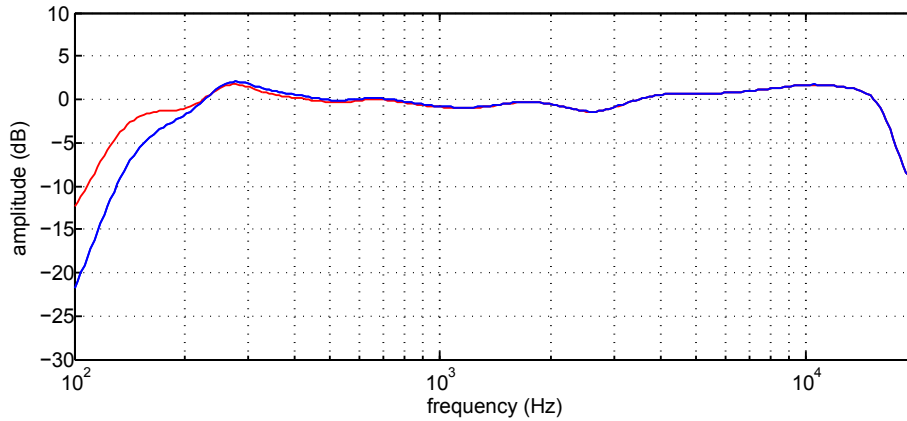

Figure 5 – Frequency response (column SA250P / SA300P+). Average of the measurements at 7, 10, 15, 20, 25, and 30m.

In red: with bass high-pass on position «100Hz», in blue: with bass high-pass on position «200Hz».

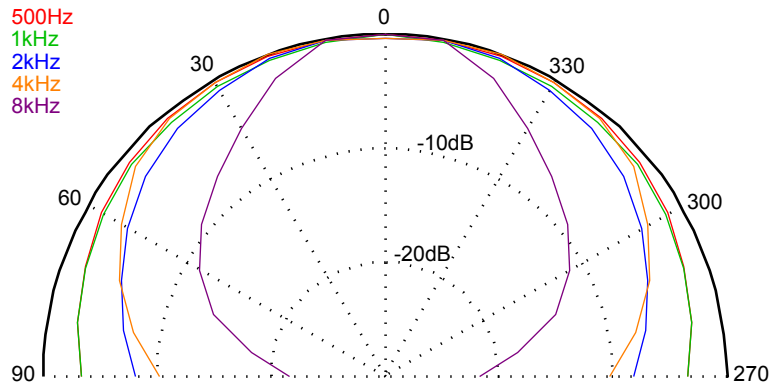
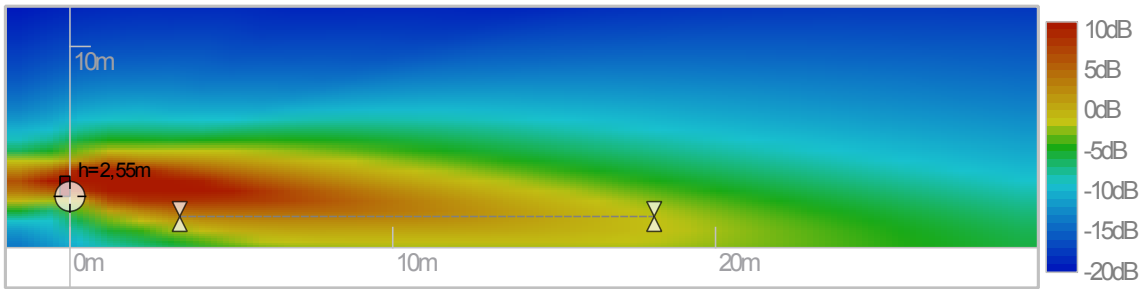
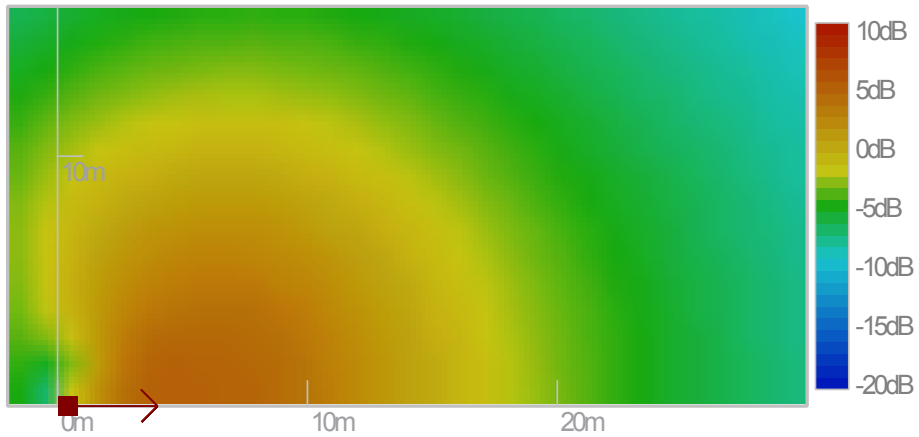

Figure 6 – Horizontal directivity (column SA250P/SA300P+)

8.2 SA100P / SA150P+ acoustical data¹



(a) SA100P / SA150P+ vertical directivity: sound level for the voice octaves (500Hz,1kHz,2kHz) in the vertical median plane.



(b) SA100P / SA150P+ horizontal directivity: sound level for the voice octaves (500Hz,1kHz,2kHz) on the listening plane.

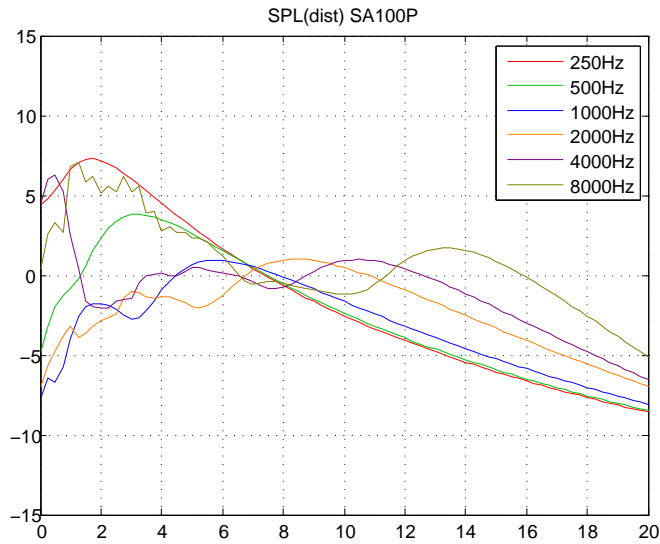

(c) Sound level by octave in the axis of the listening plane in front of the column with respect to the distance from the column.

Figure 7 – SA100P / SA150P+ acoustical data.

¹Column is in nominal position. Levels are referenced to the mean SPL on the listening area.

8.3 SA180P / SA230P+ acoustical data²

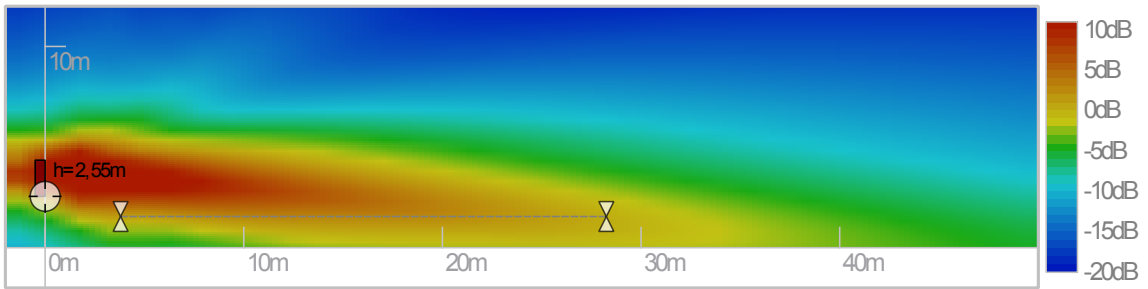

(a) SA180P / SA230P+ vertical directivity: sound level for the voice octaves (500Hz,1kHz,2kHz) in the vertical median plane.

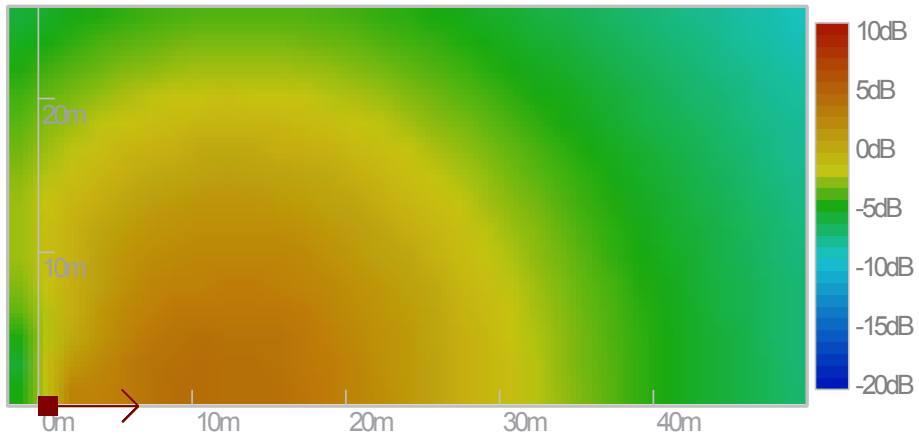

(b) SA180P / SA230P+ horizontal directivity: sound level for the voice octaves (500Hz,1kHz,2kHz) on the listening plane.

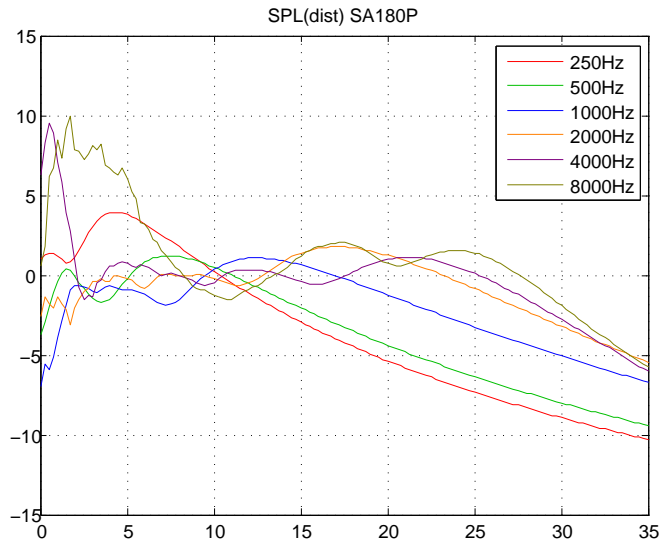

(c) Sound level by octave in the axis of the listening plane in front of the column with respect to the distance from the column.

Figure 8 – SA180P / SA230P+ acoustical data.

²Column is in nominal position. Levels are referenced to the mean SPL on the listening area.

8.4 SA250P / SA300P+ acoustical data³

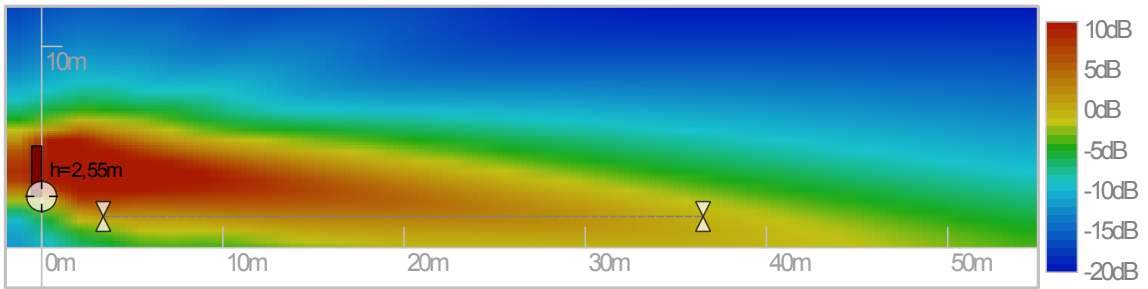

(a) SA250P / SA300P+ vertical directivity: sound level for the voice octaves (500Hz,1kHz,2kHz) in the vertical median plane.

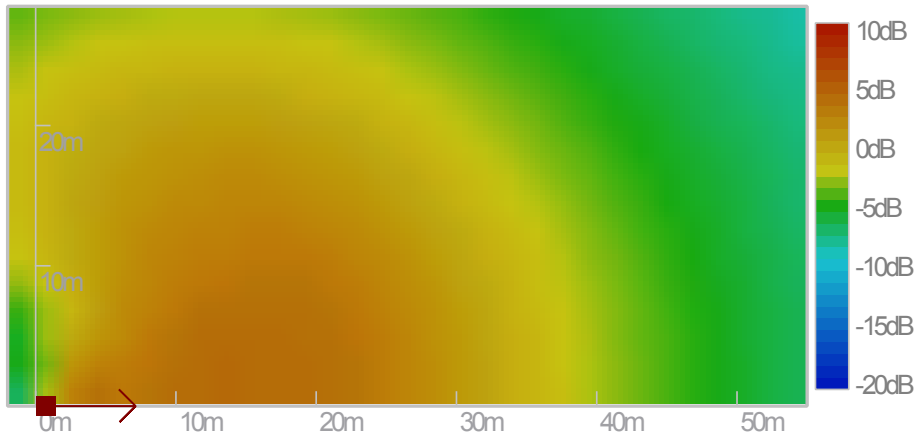

(b) SA250P / SA300P+ horizontal directivity: sound level for the voice octaves (500Hz,1kHz,2kHz) on the listening plane.

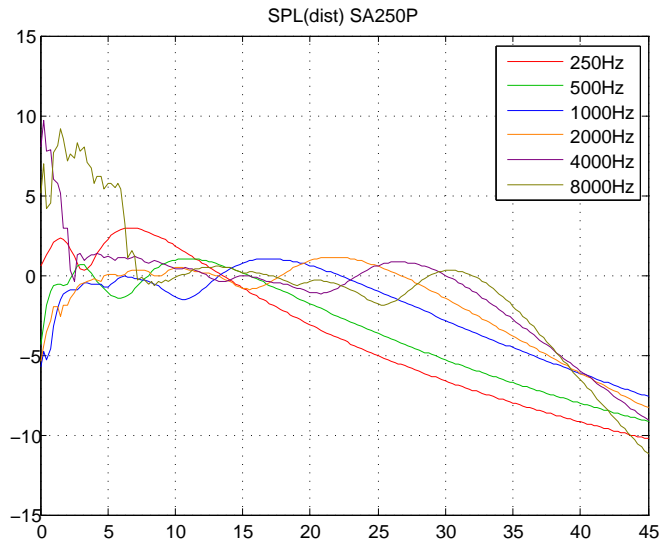

(c) Sound level by octave in the axis of the listening plane in front of the column with respect to the distance from the column.

Figure 9 – SA250P / SA300P+ acoustical data.

³Column is in nominal position. Levels are referenced to the mean SPL on the listening area.

8.5 SA400P / SA450P+ acoustical data⁴

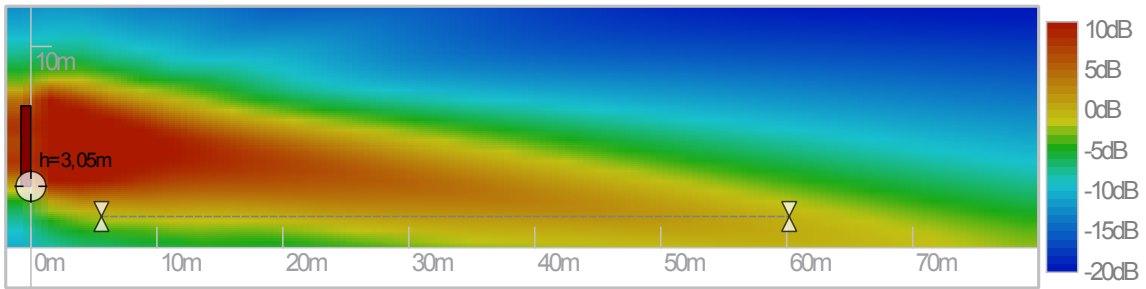

(a) SA400P vertical directivity: sound level for the voice octaves (500Hz,1kHz,2kHz) in the vertical median plane.

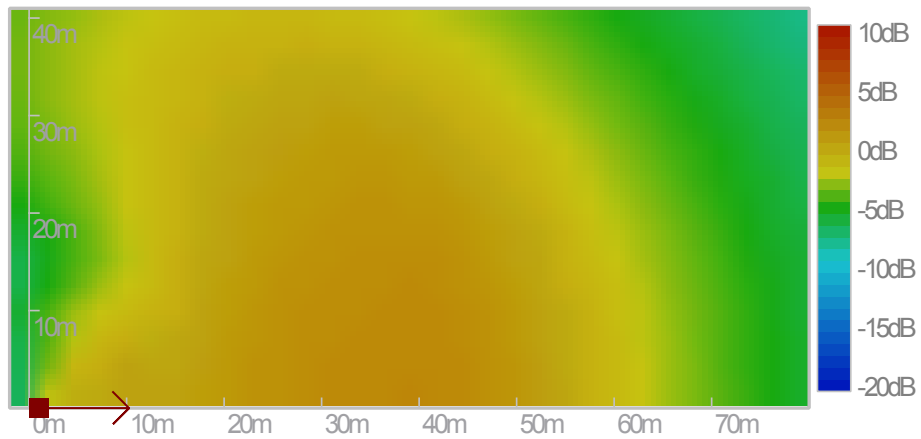

(b) SA400P horizontal directivity: sound level for the voice octaves (500Hz,1kHz,2kHz) on the listening plane.

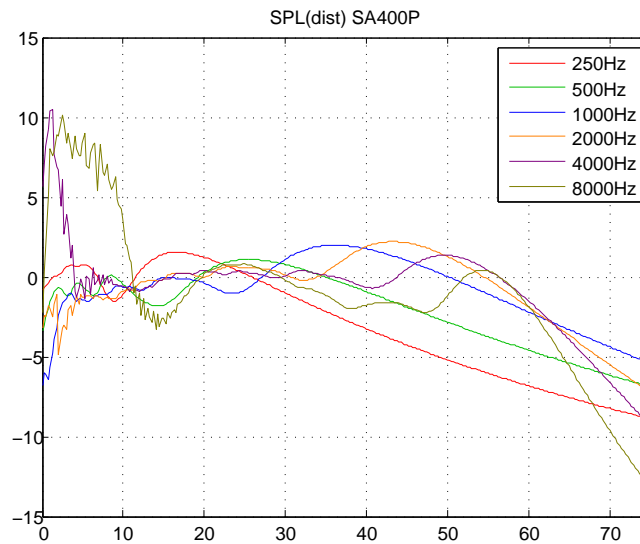

(c) Sound level by octave in the axis of the listening plane in front of the column with respect to the distance from the column.

Figure 10 – SA400P acoustical data.

⁴Column is in nominal position. Levels are referenced to the mean SPL on the listening area.

8.6 SA180S / SA230S+ acoustical data⁵

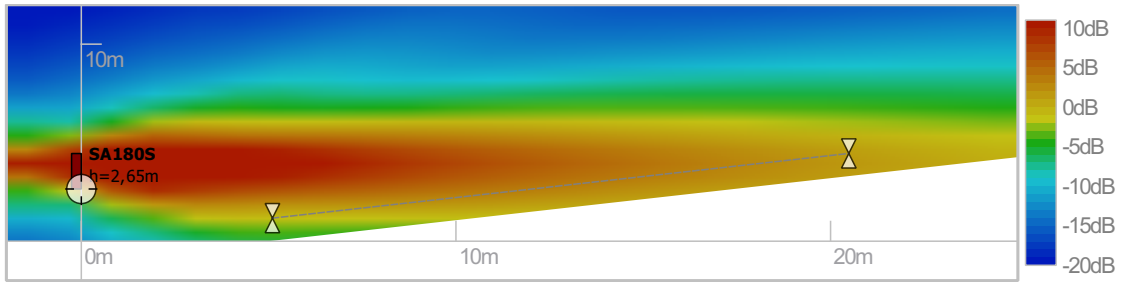

(a) SA180S / SA230S+ vertical directivity: sound level for the voice octaves (500Hz,1kHz,2kHz) in the vertical median plane.

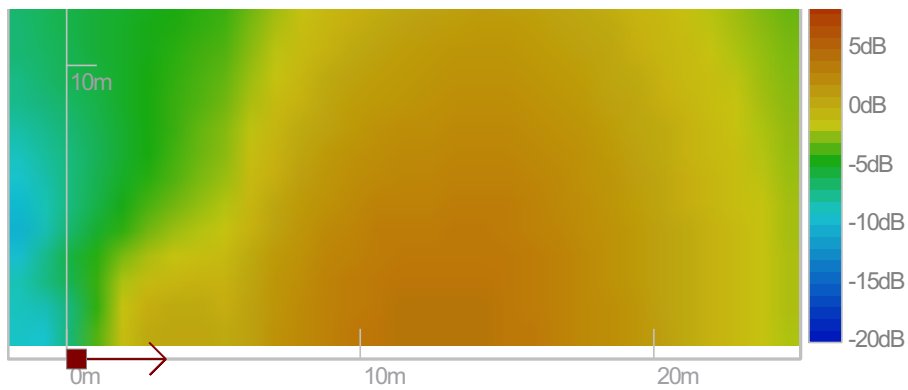

(b) SA180S / SA230S+ horizontal directivity: sound level for the voice octaves (500Hz,1kHz,2kHz) on the listening plane.

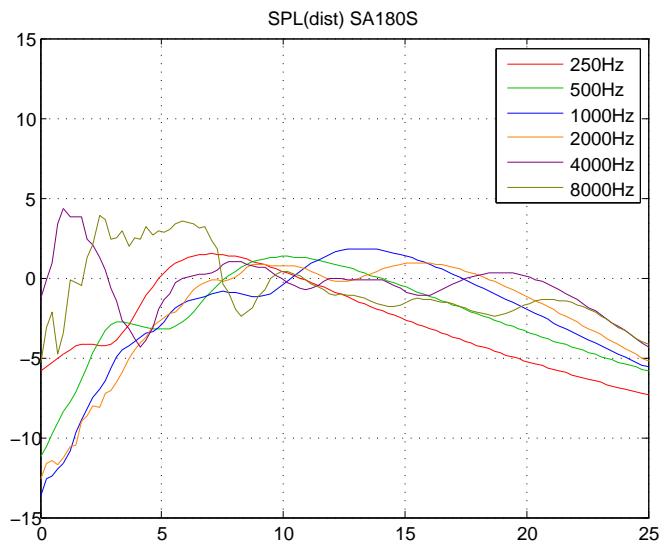

(c) Sound level by octave in the axis of the listening plane in front of the column with respect to the distance from the column.

Figure 11 – SA180S / SA230S+ acoustical data.

⁵Column is in nominal position. Levels are referenced to the mean SPL on the listening area.

8.7 SA250S / SA300S+ acoustical data⁶

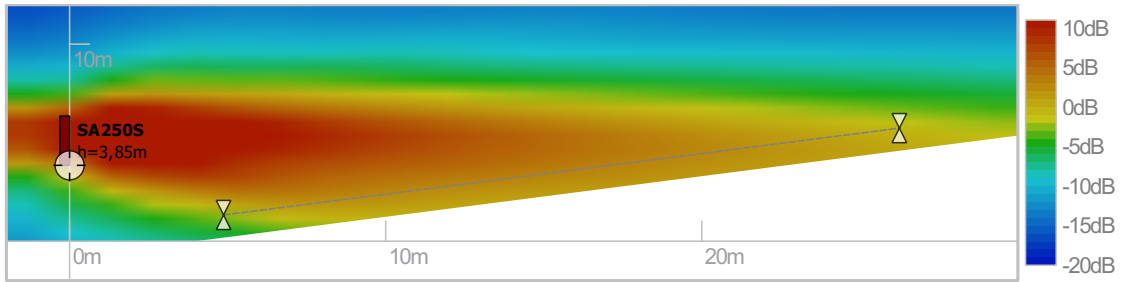

(a) SA250S / SA300S+ vertical directivity: sound level for the voice octaves (500Hz,1kHz,2kHz) in the vertical median plane.

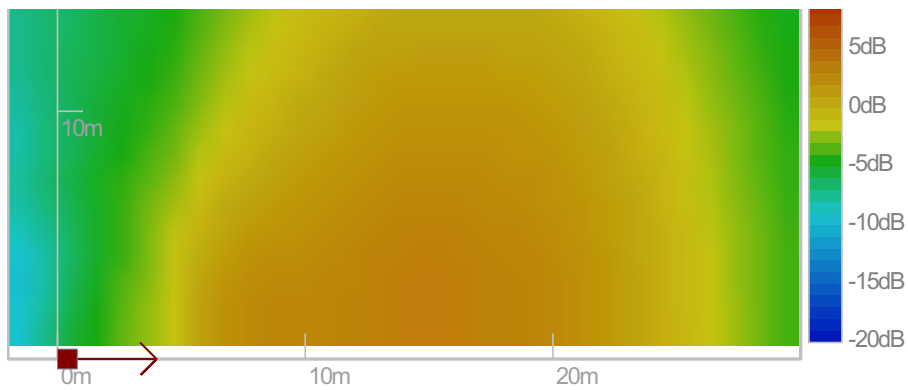

(b) SA250S / SA300S+ horizontal directivity: sound level for the voice octaves (500Hz,1kHz,2kHz) on the listening plane.

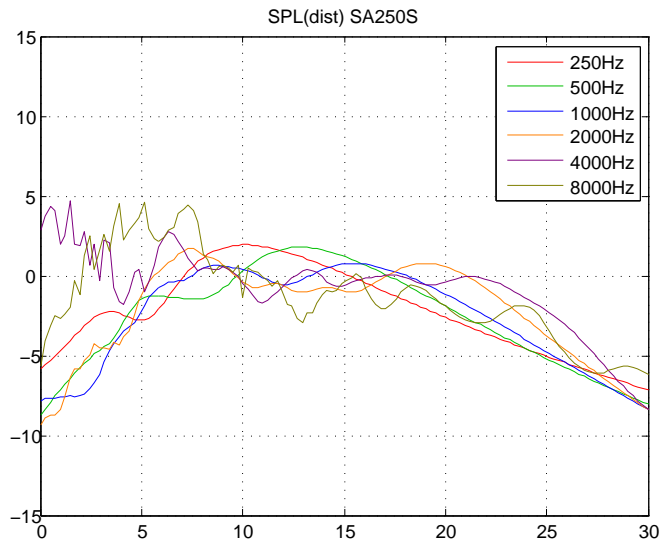

(c) Sound level by octave in the axis of the listening plane in front of the column with respect to the distance from the column.

Figure 12 – SA250S / SA300S+ acoustical data.

⁶Column is in nominal position. Levels are referenced to the mean SPL on the listening area.

List of Figures

1	StepArray+ control software: main screen.	10
2	StepArray+ control software: column settings screen.	10
3	Column mounting on a wall	11
4	Fixing brackets for wall mounting of StepArray columns.	12
5	Frequency response (column SA250P / SA300P+)	15
6	Horizontal directivity (column SA250P/SA300P+)	15
7	SA100P / SA150P+ acoustical data.	16
8	SA180P / SA230P+ acoustical data.	17
9	SA250P / SA300P+ acoustical data.	18
10	SA400P acoustical data.	19
11	SA180S / SA230S+ acoustical data.	20
12	SA250S / SA300S+ acoustical data.	21

www.activeaudio.fr

info@activeaudio.fr

332 Bd Marcel Paul, CP602 - 44806 Saint-Herblain Cedex - France

Tel: +33 (0)2 404 666 64

Contact

